



FI 25, FI 30 & FI 40 FINGER ICE MAKERS



FI 25, FI 30 & FI 40

- 12g finger ice ideal for use by restaurants, hotels, licensed bars, juice bars, take away outlets and health care facilities
- 18/10 grade stainless steel cabinets with integrated food grade polyethylene storage bin
- simple, reliable spray system no paddles



FI 25, FI 30 & FI 40 FINGER ICE MAKERS

Specifications

Power

Voltage – 240-50Hz

Amps – FI 25 2.5 – FI 30 2.9
FI 40 3.1

Refrigerant

R404a

Shipping Details

FI 25 35x60x64cm (34kg)

FI 30 50X64X66cm (43kg)

FI 40 50X60X81cm (47kg)

Water Supply Requirements

3/4" BSP male stop cock

Drainage

Floor waste within 1 metre of machine

Note! Must be below machine outlet

Ice Making Capacity (kg/24hours)

	Production	Storage*
FI 25	25	6
FI 30	30	15
FI 40	40	16

	Water In (1)		Drainage (2)		Power In (3)	
	A	B	A	B	A	B
FI 25	205	130	205	29	98	29
FI 30	100	117	55	49	123	41
FI 40	100	117	55	49	123	41

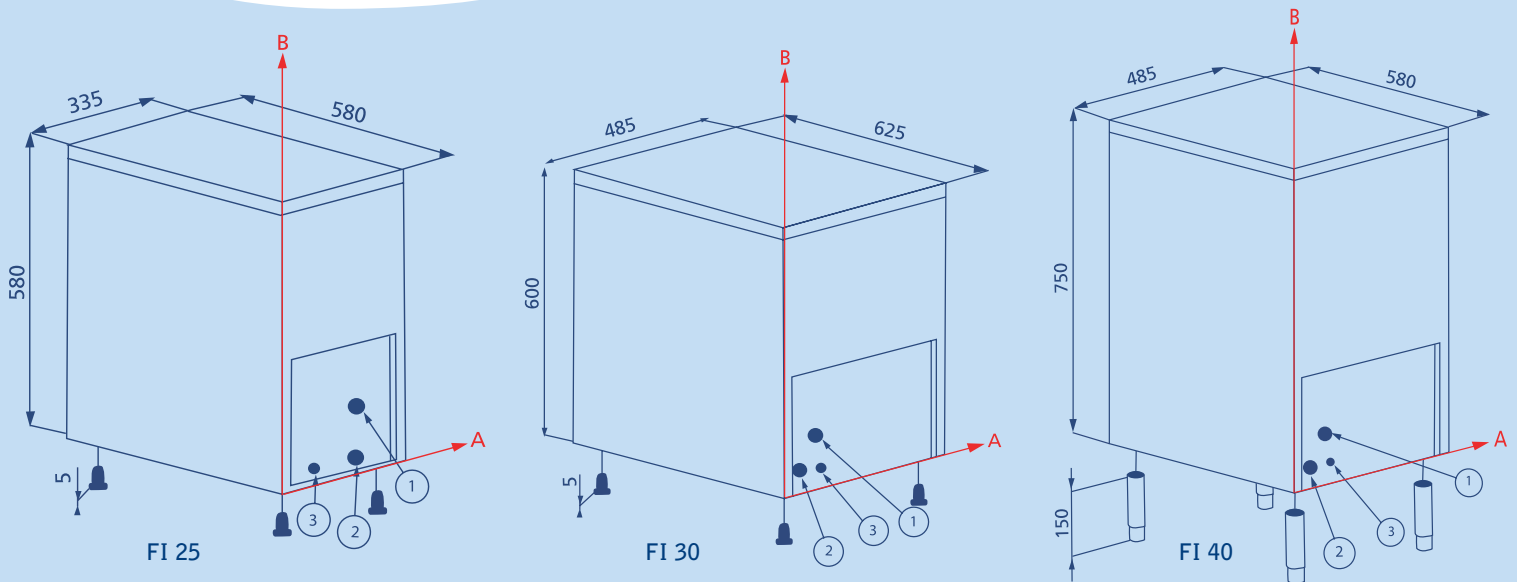

*Storage bin capacity will vary depending on ice size
Continuing product improvement may necessitate changes of specifications without notice.

Distributed By

For more information or the name
of your local sales agent call:

Stuart Manufacturing

1 Jaylem Crescent Padstow NSW 2211

Sales 1300 301 380 • General Enquiries 02 9773 3711

Facsimile 02 9773 4400 • Email ice@stuman.com.au

Website www.stuman.com.au